

K. V. BOUSKÉ
MATERIÁL: 14.2.
BOD: A.A.

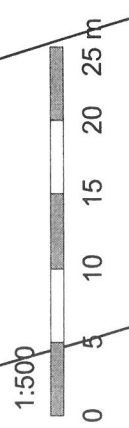

k.ú. Rouské - 1144/69

MATERIÁL: *14.2.*
KOD: *1.1.*

1144/67

1144/68

1144/69

1144/70

1144/71

1144/72

1144/73

1144/74

1144/75

1144/8

1144/7

1144/6

1144/5

1144/4

1:500

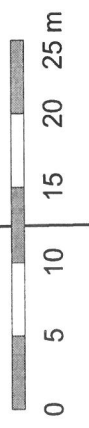

Е.В. ОНКОЗИН

MATERIÁL: 14.2.
BOD: 1.2.-1.5.2.1.2.2.

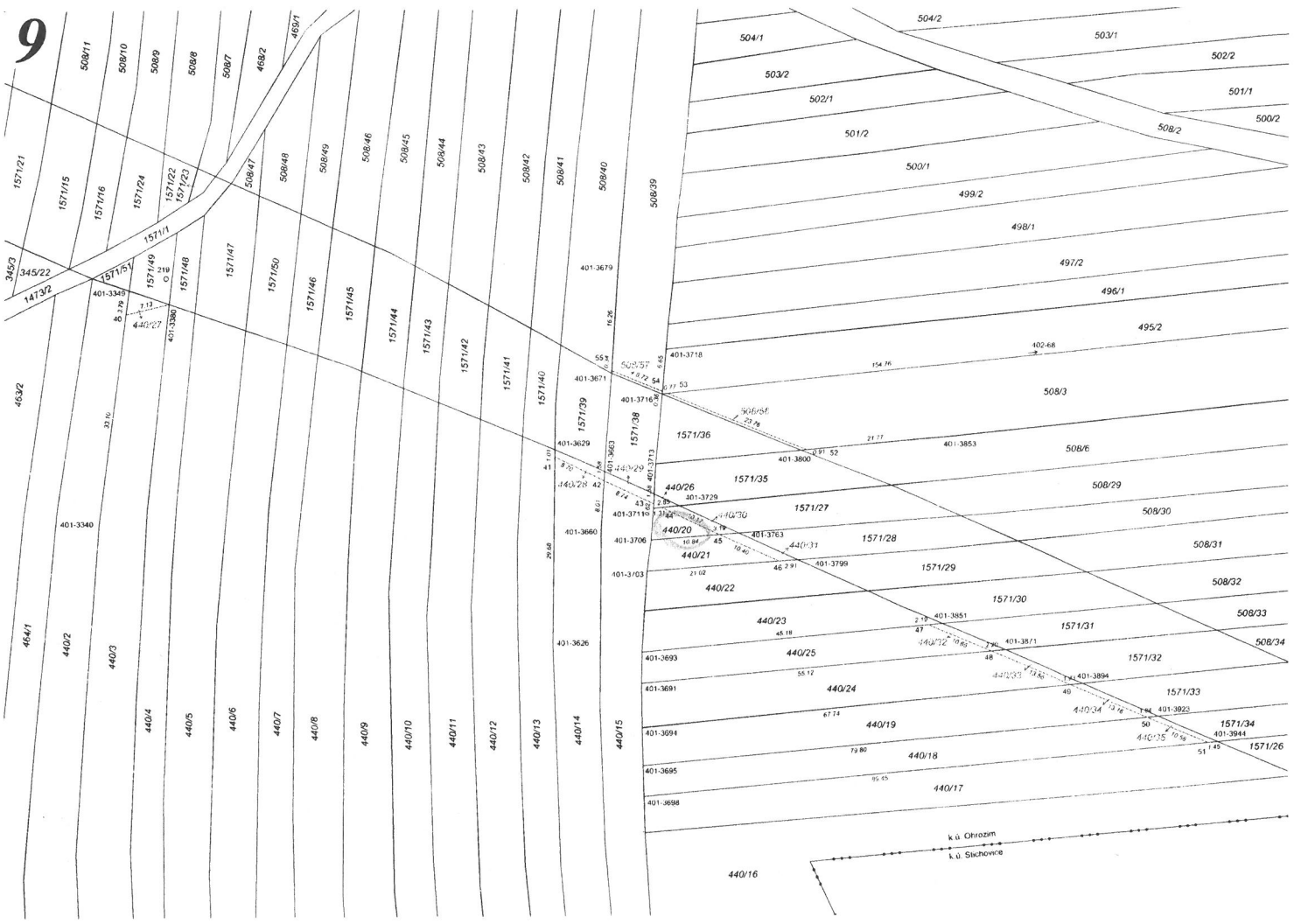

k.ú. Vícov

MATERIÁL: 14.2.
BCD: 1.6.12.3.

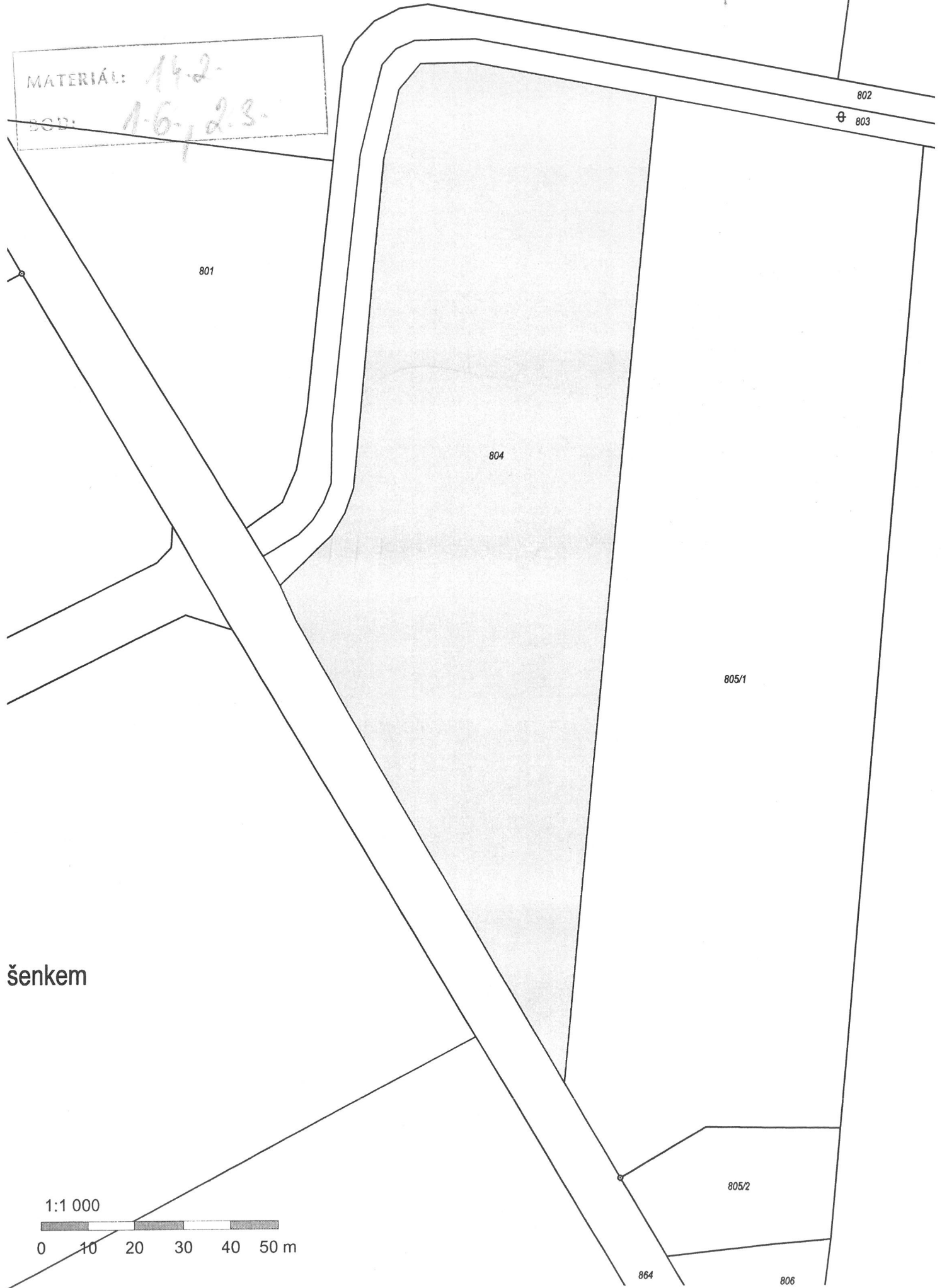

šenkem

1:1 000

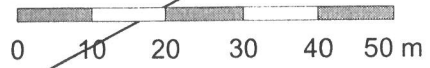

864

806

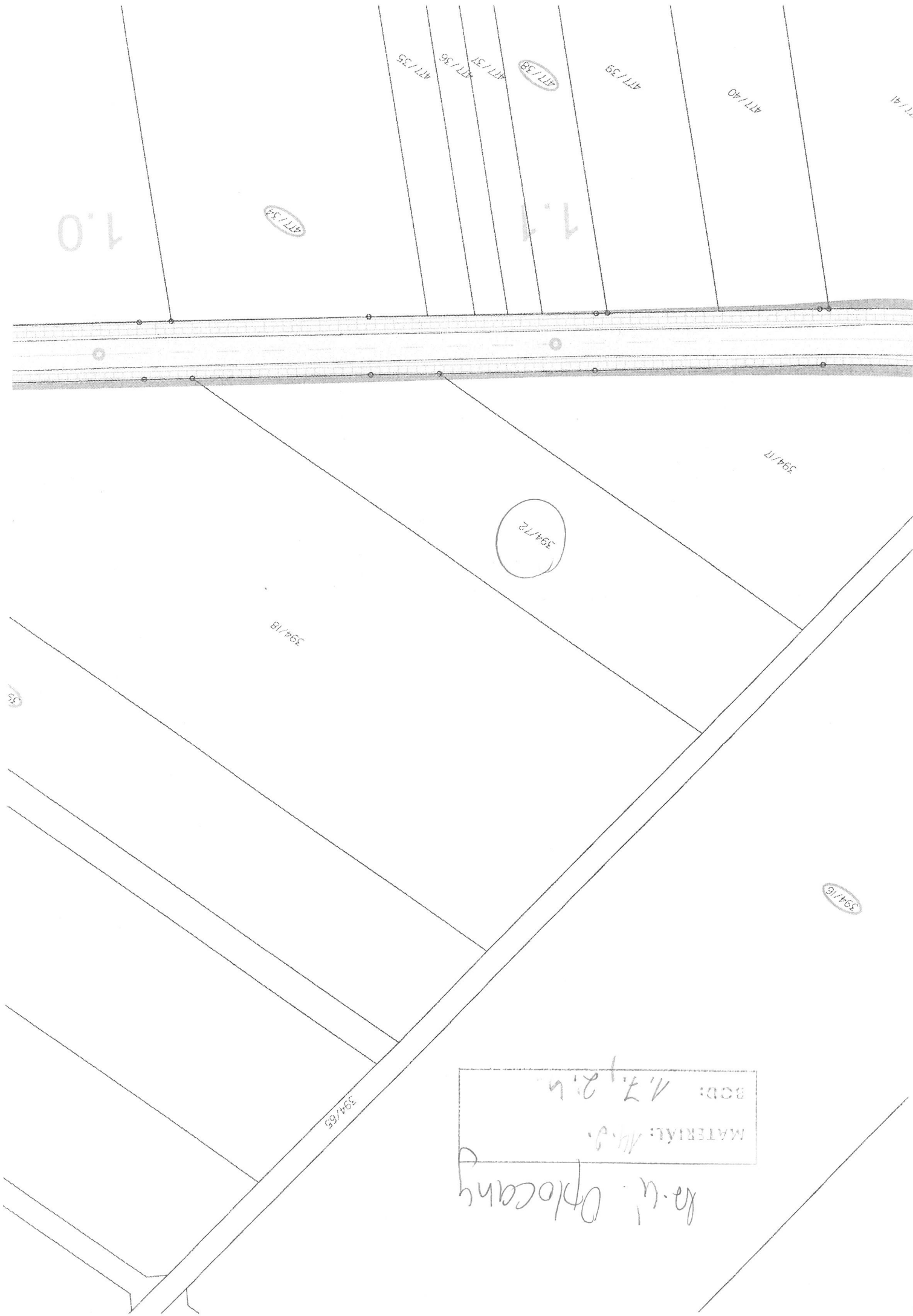

1.0

47/34

47/38

47/35

47/36

47/37

47/38

47/39

47/40

47/41

394/7

394/12

394/13

394/16

394/65

K.A. Orloman
 MATERIAL: M.S.
 BOB: 1.7.2.4

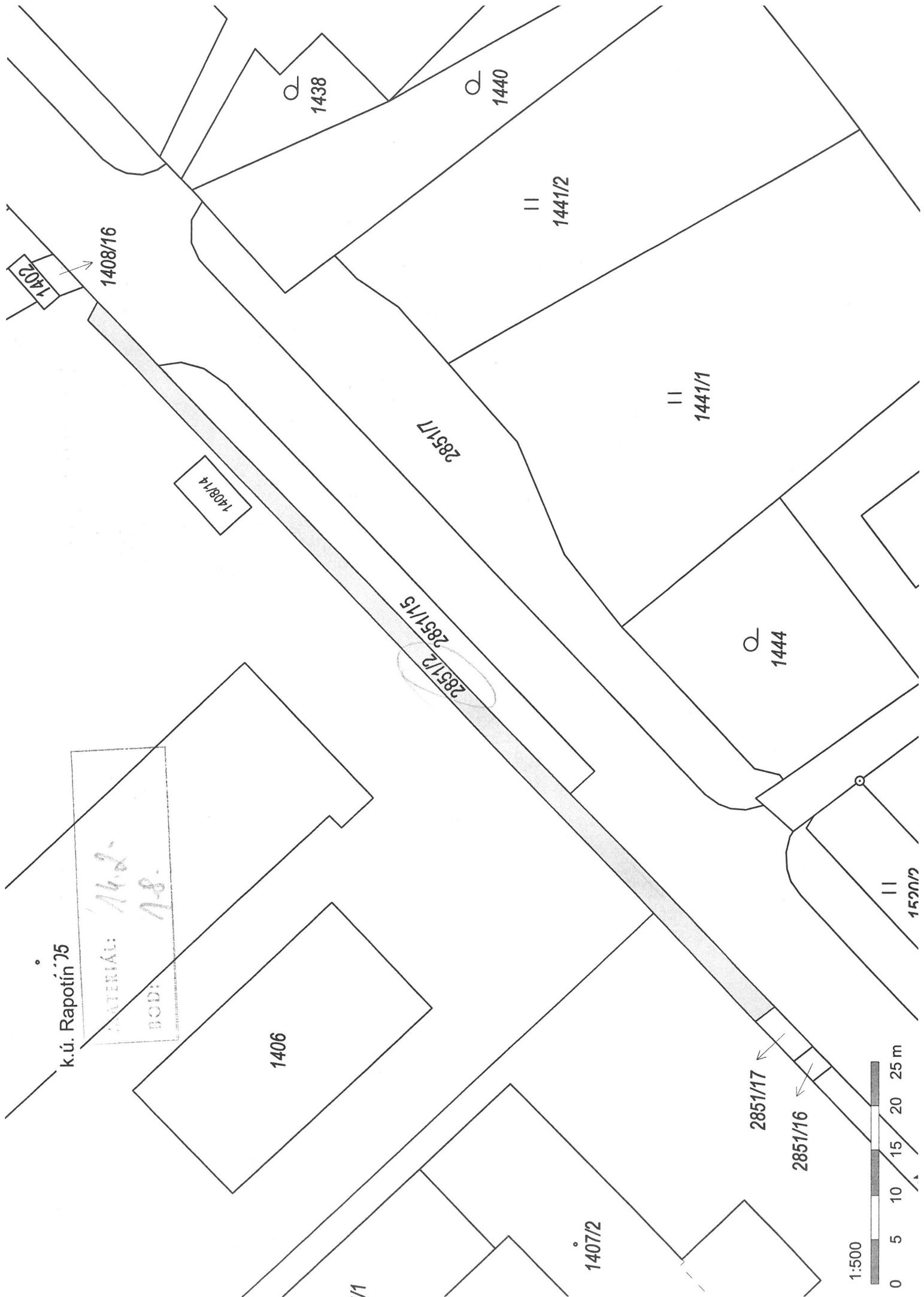

k.ú. Rapotín 75

MATERIÁL: 14.2.
BOD: 18.

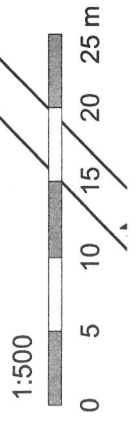

1119/1

k.ú. Jeseník

MATERIÁL:

BOB:

14.2.
1.9.



64. LESNÝ U PROSEDOVA

MATERIÁL: 14.2.

BOD: 1.10

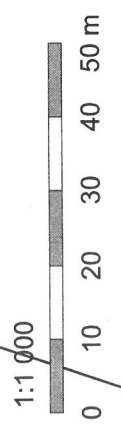
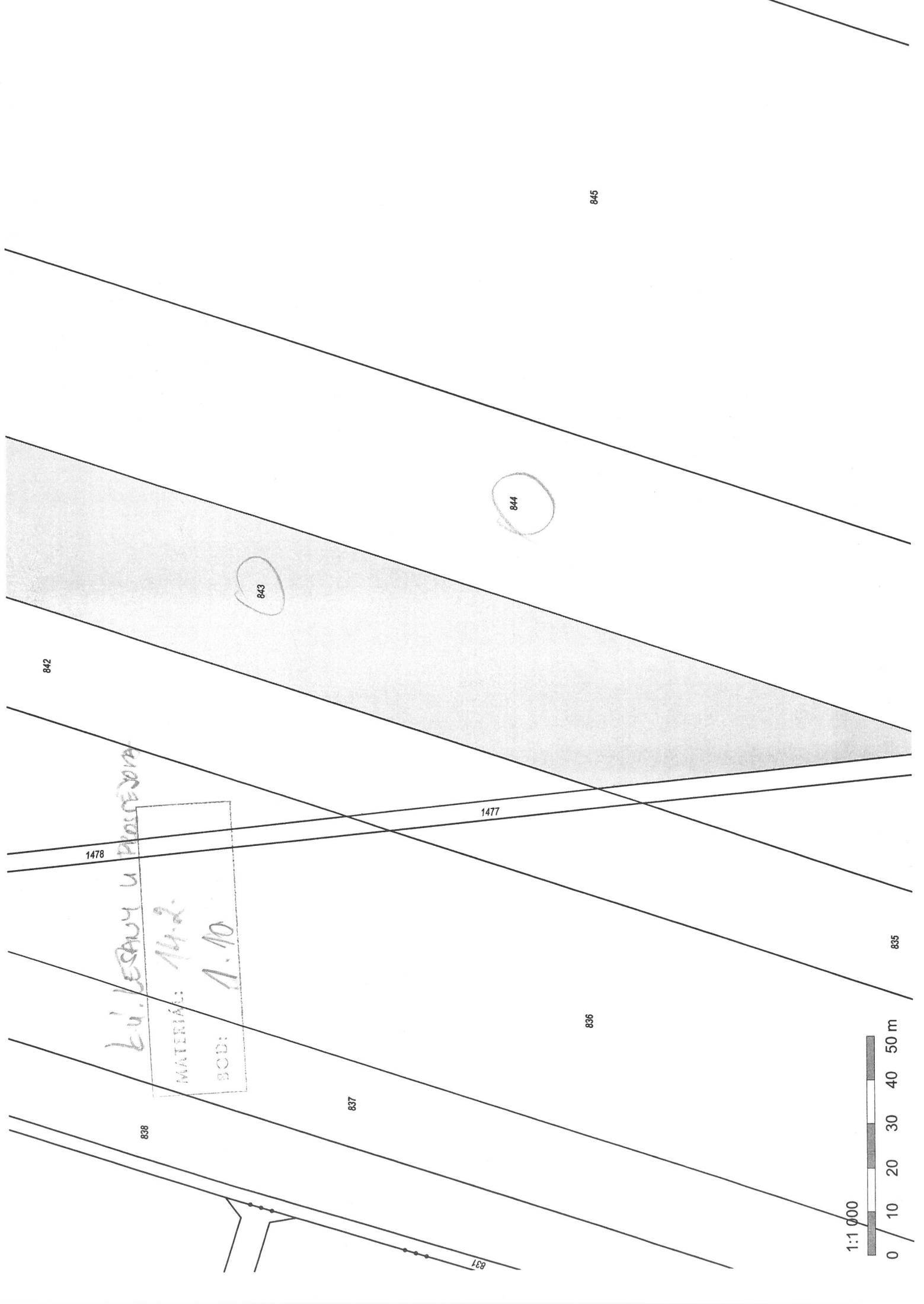

kv. LESANŮV U PV.

ADRESA: M.Š.
POD: A.10.

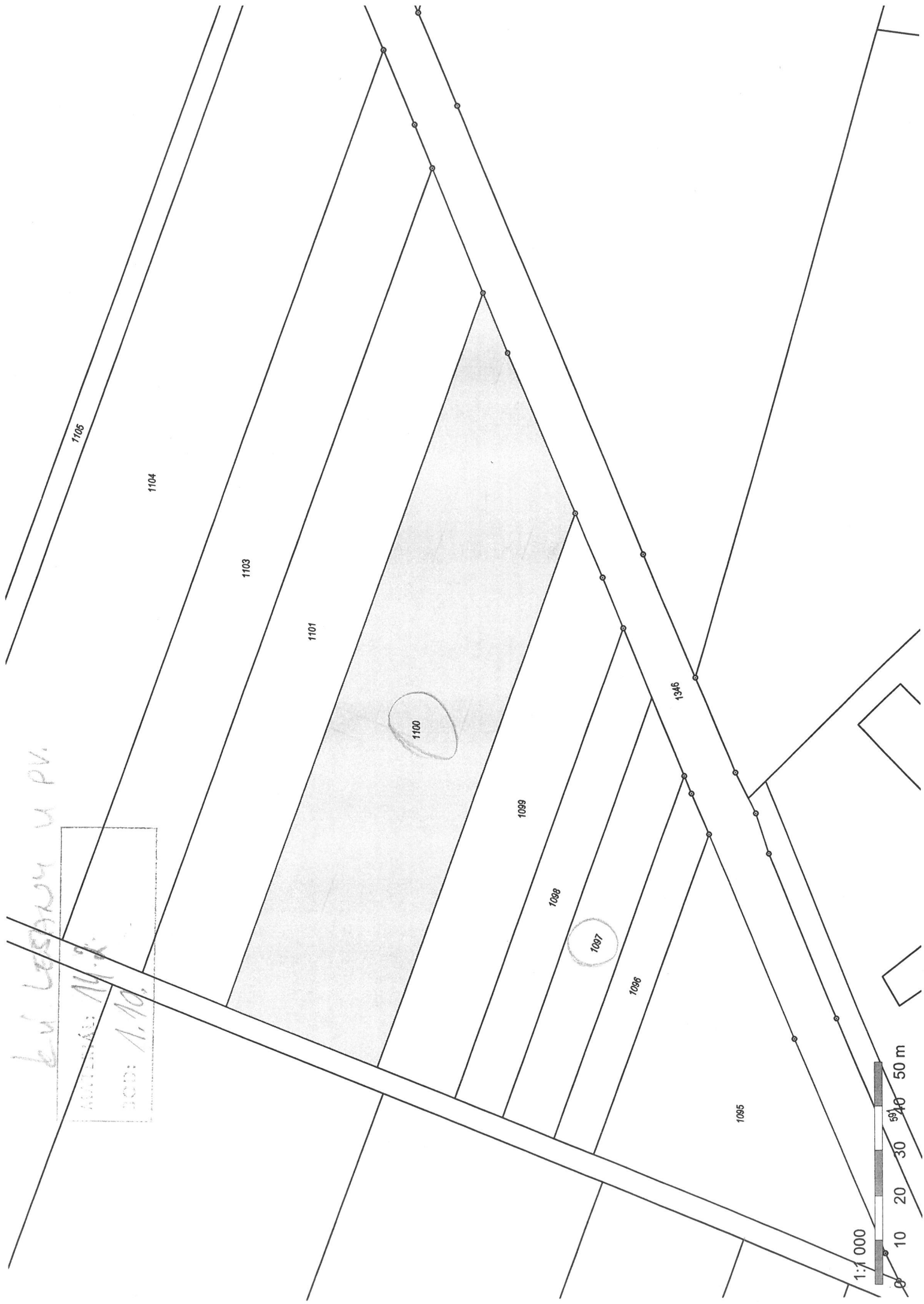

h.v. Susida u Přetova

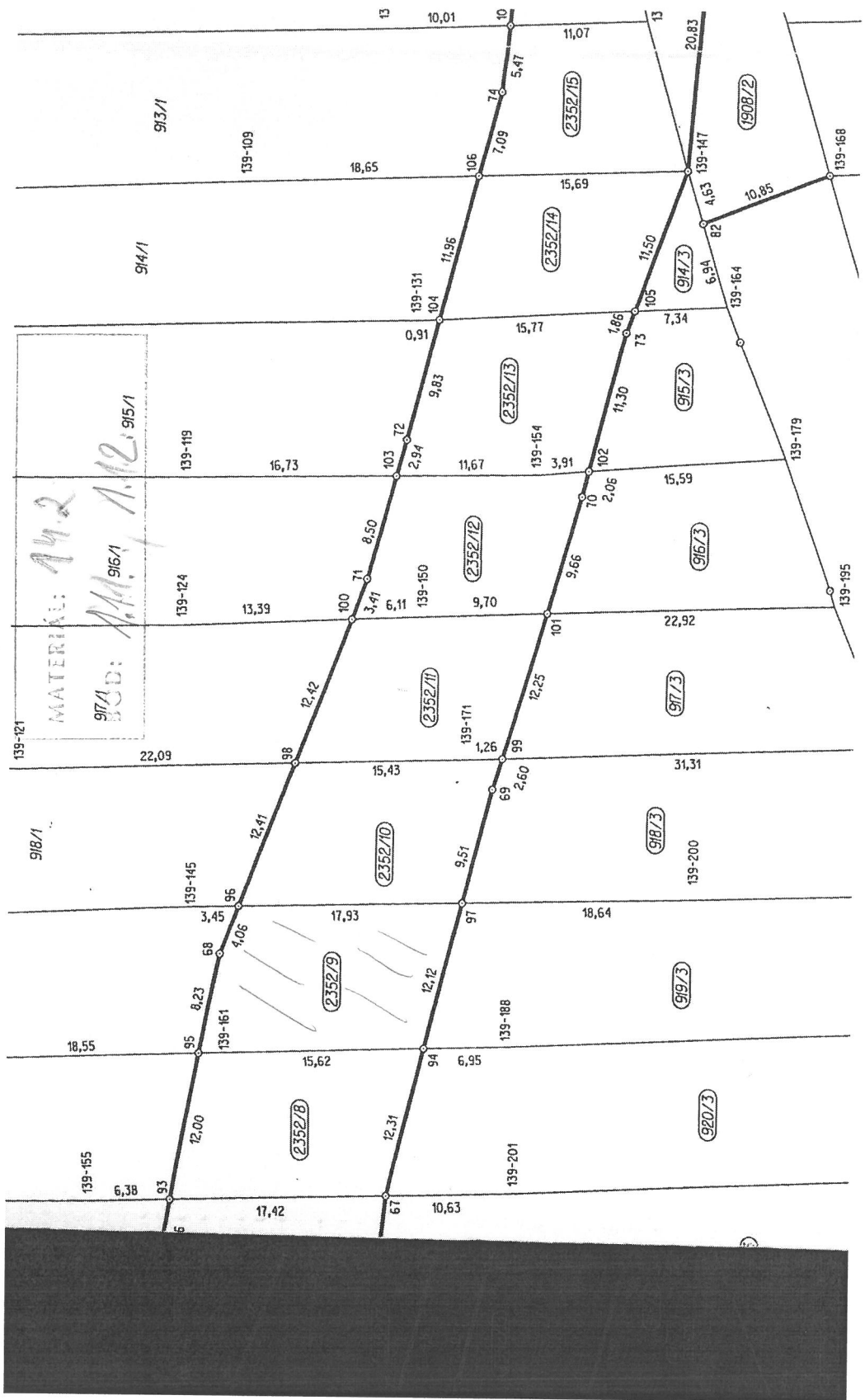

MATERIAL: 142
 BOB: 144, 916/1, 112, 915/1

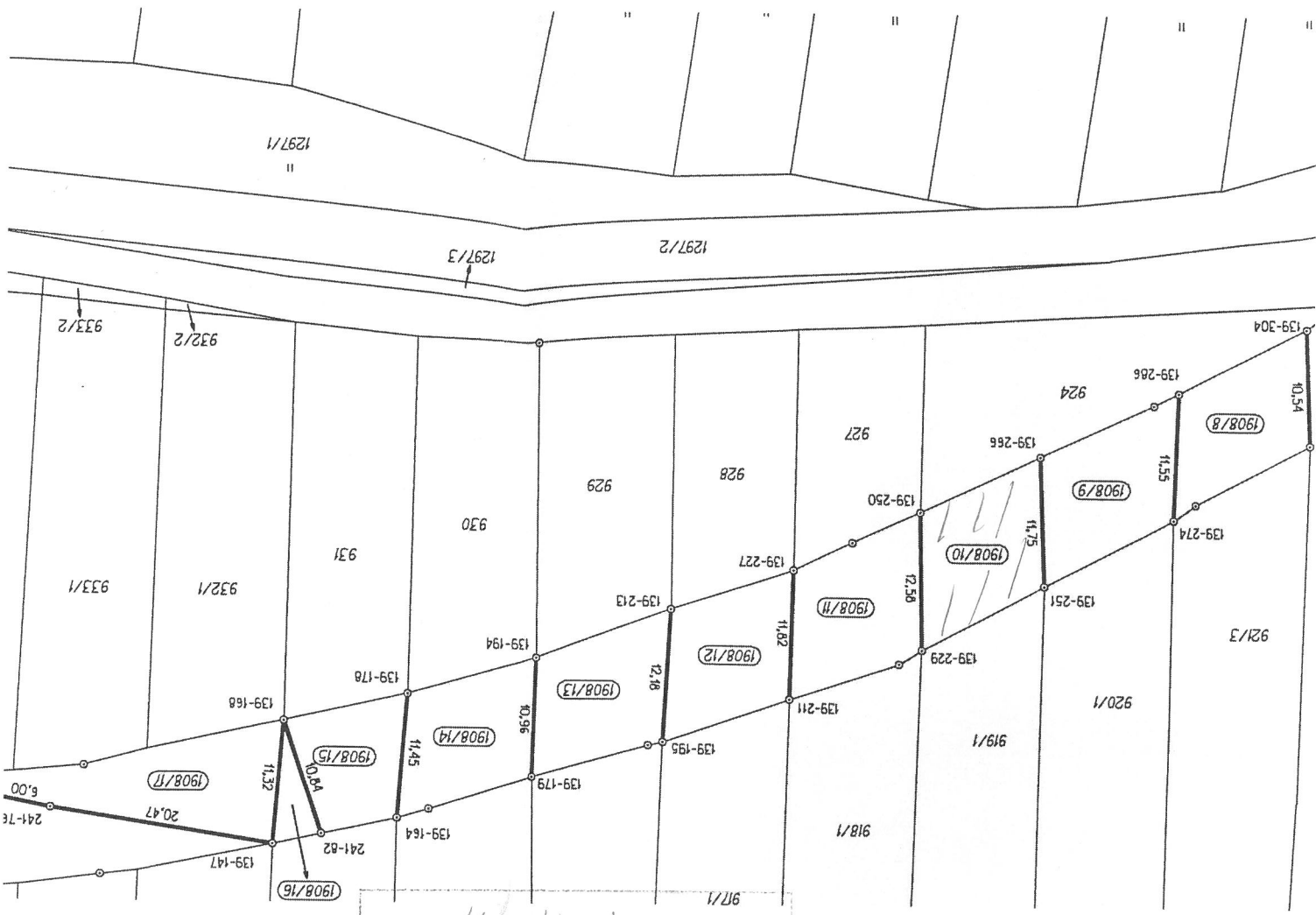

WATERWAYS: 14.2
 BOB: 1.0 M. A.M.
 97/1

Dr. Suvica u Pretova

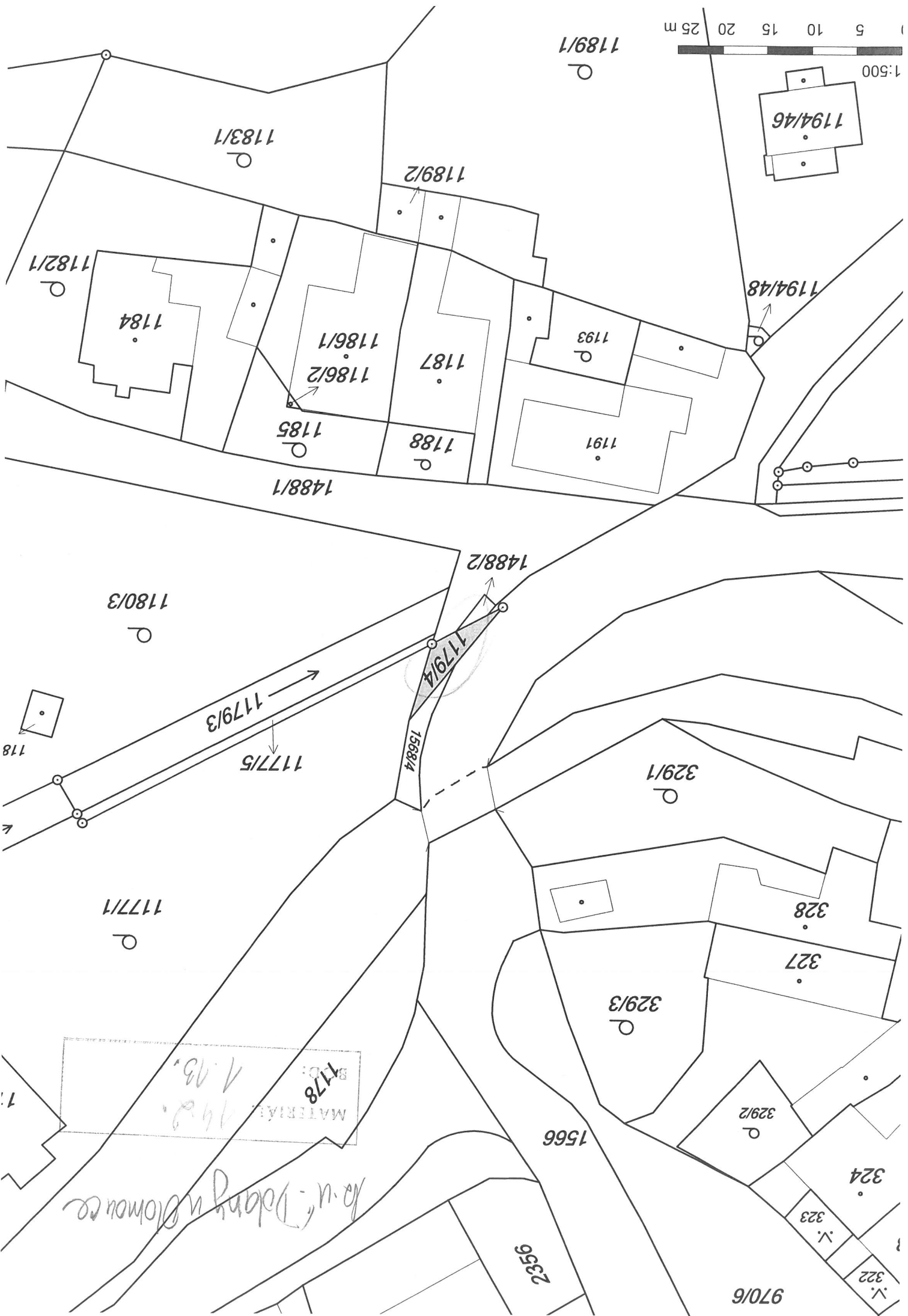

ka.u. Dobry u Blomauce
MATERIAL 1178
140.
1.13.



č.č. STERNBERK
MATERIÁL: 14.2.
POD: 2.5.

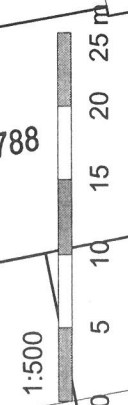



L.V. PRABCOOV
MATERIAL: 14.2.
COD: 2.6.

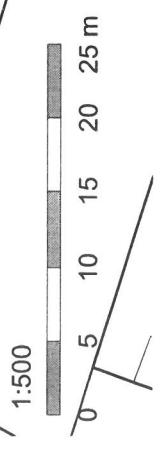

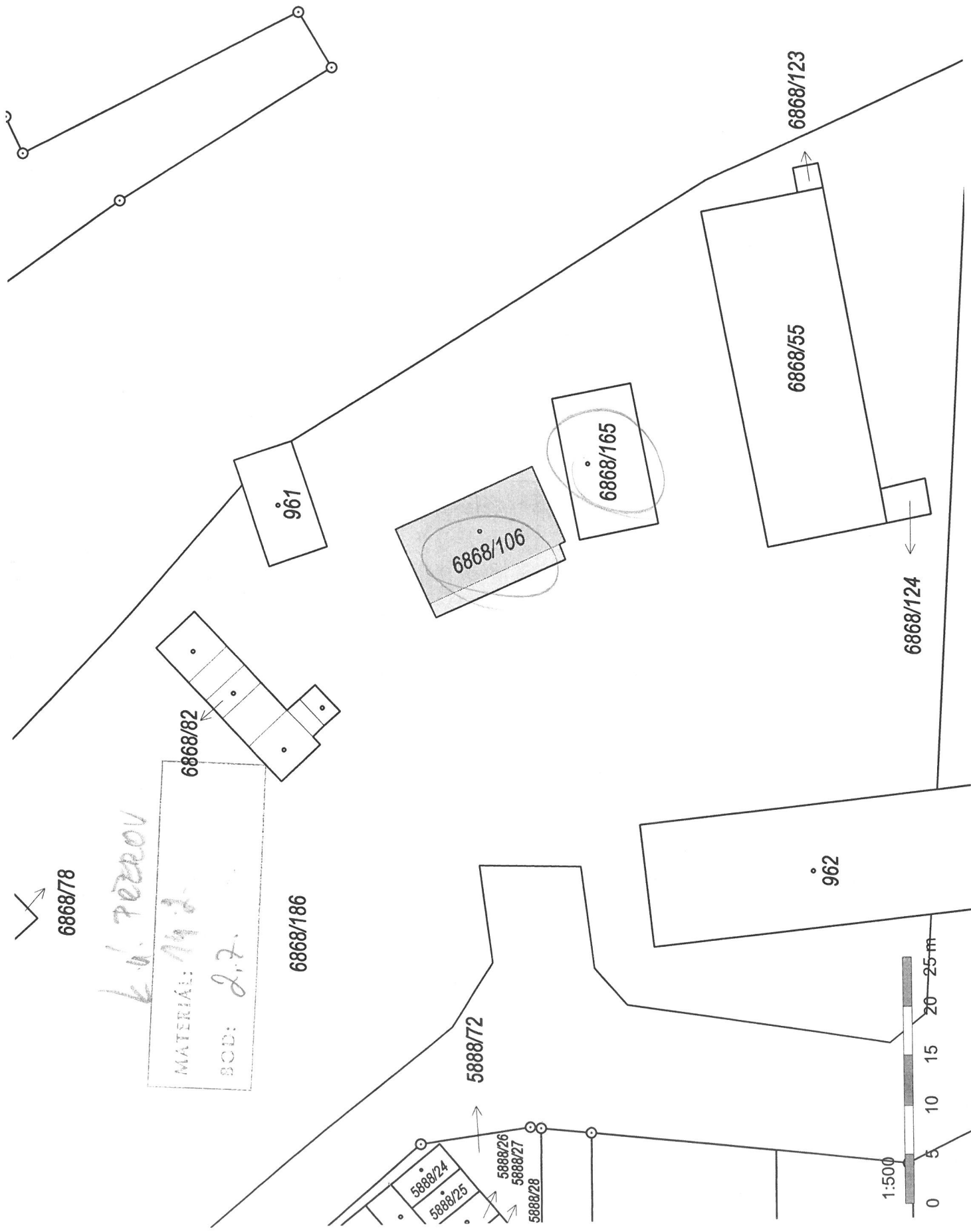

Л.В. ПЕРЛОВ

MATERIAL: 14.2.

СОД: 2.7.

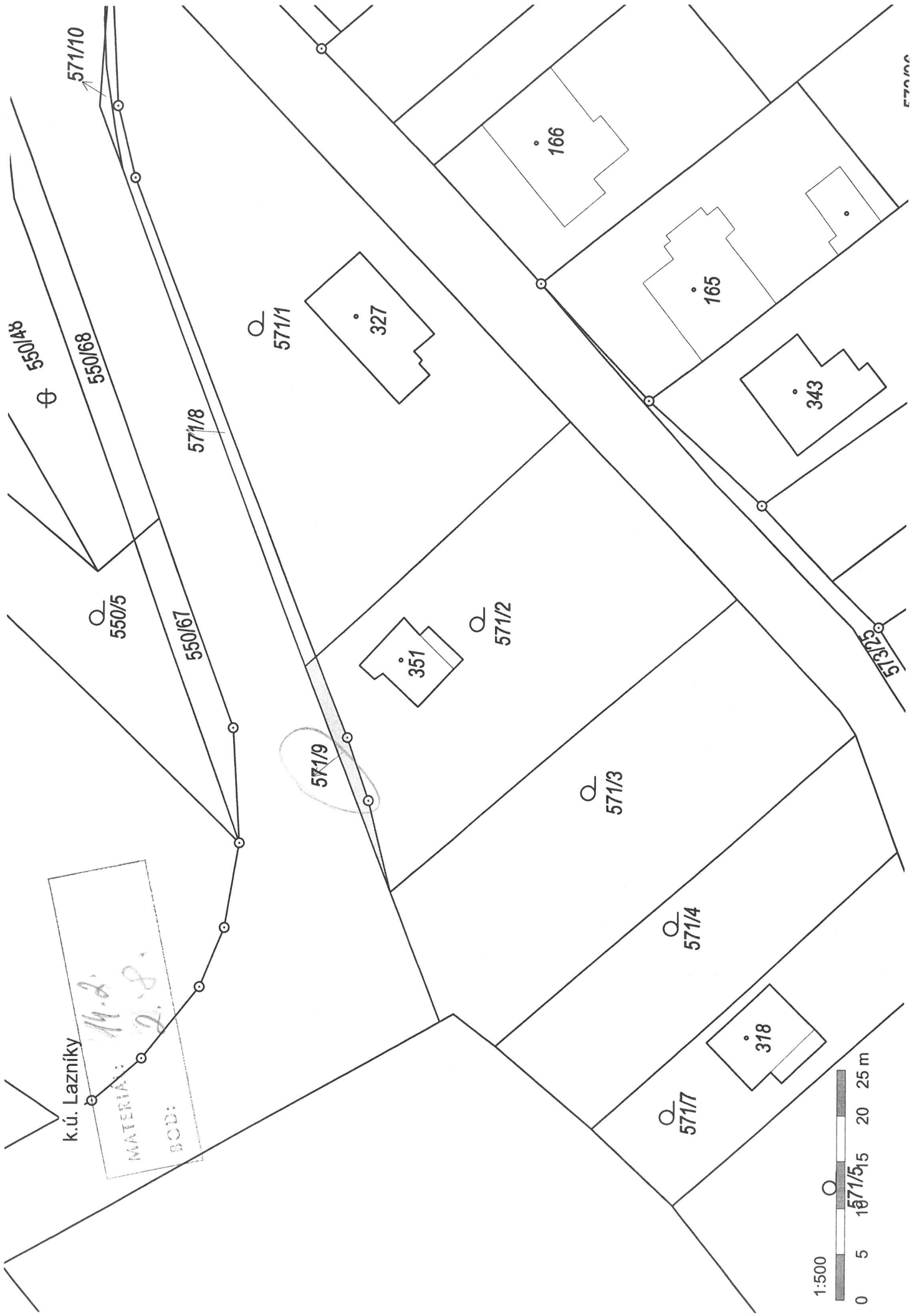

550/14

571/10

550/5

550/67

550/68

571/8

571/1

351

571/2

327

166

571/3

571/4

165

343

571/7

318

573/25

570/12

k.ú. Lazníky

MATERIA: M.Š.

BOD: Z.Š.

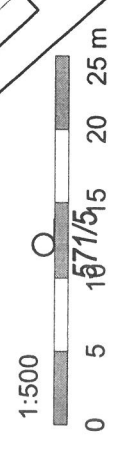

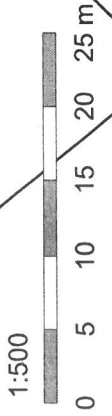
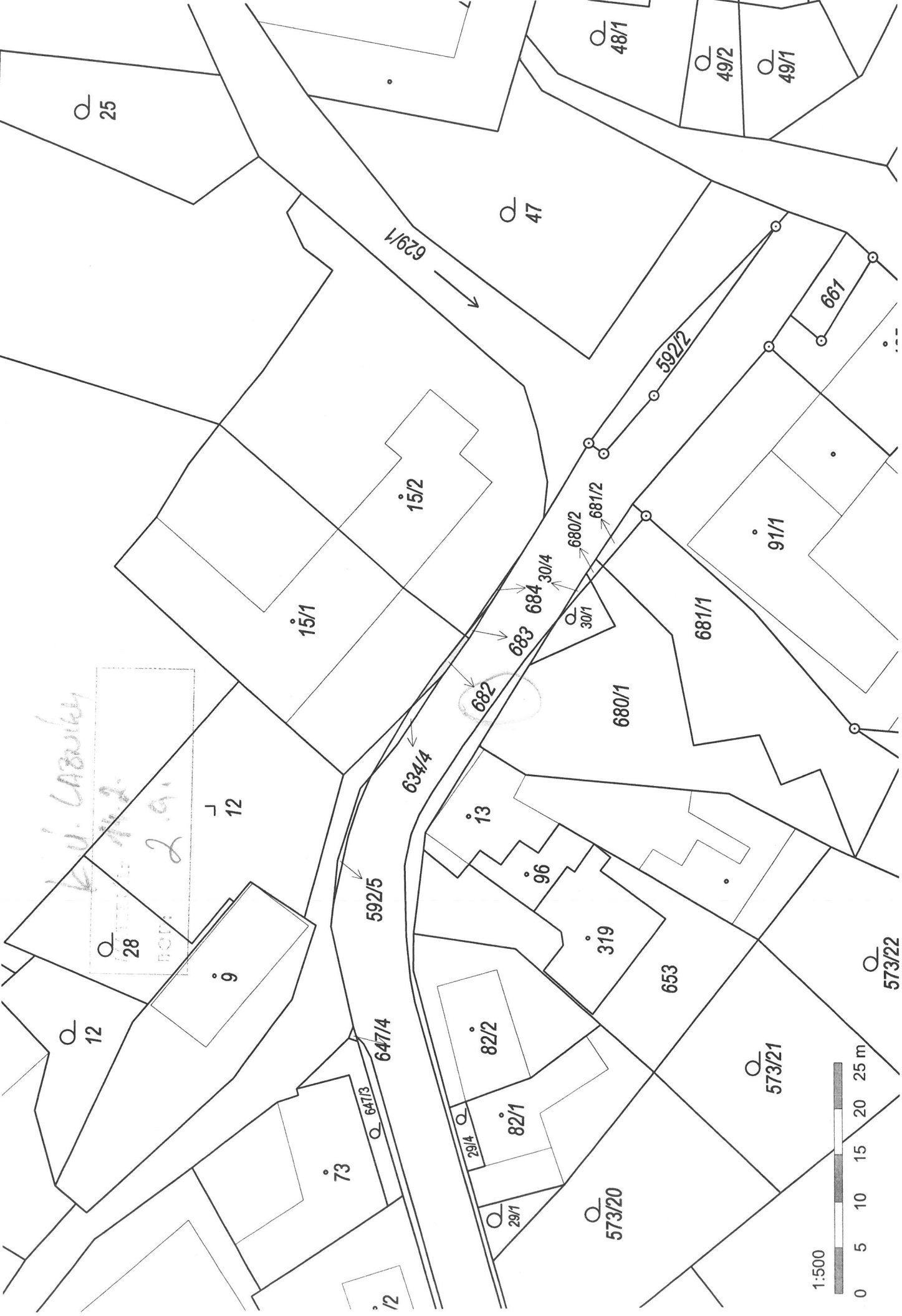

k. u. CABONIA

MATERIA: 14.2.
BOD: 2.10.

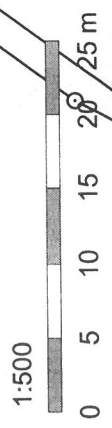
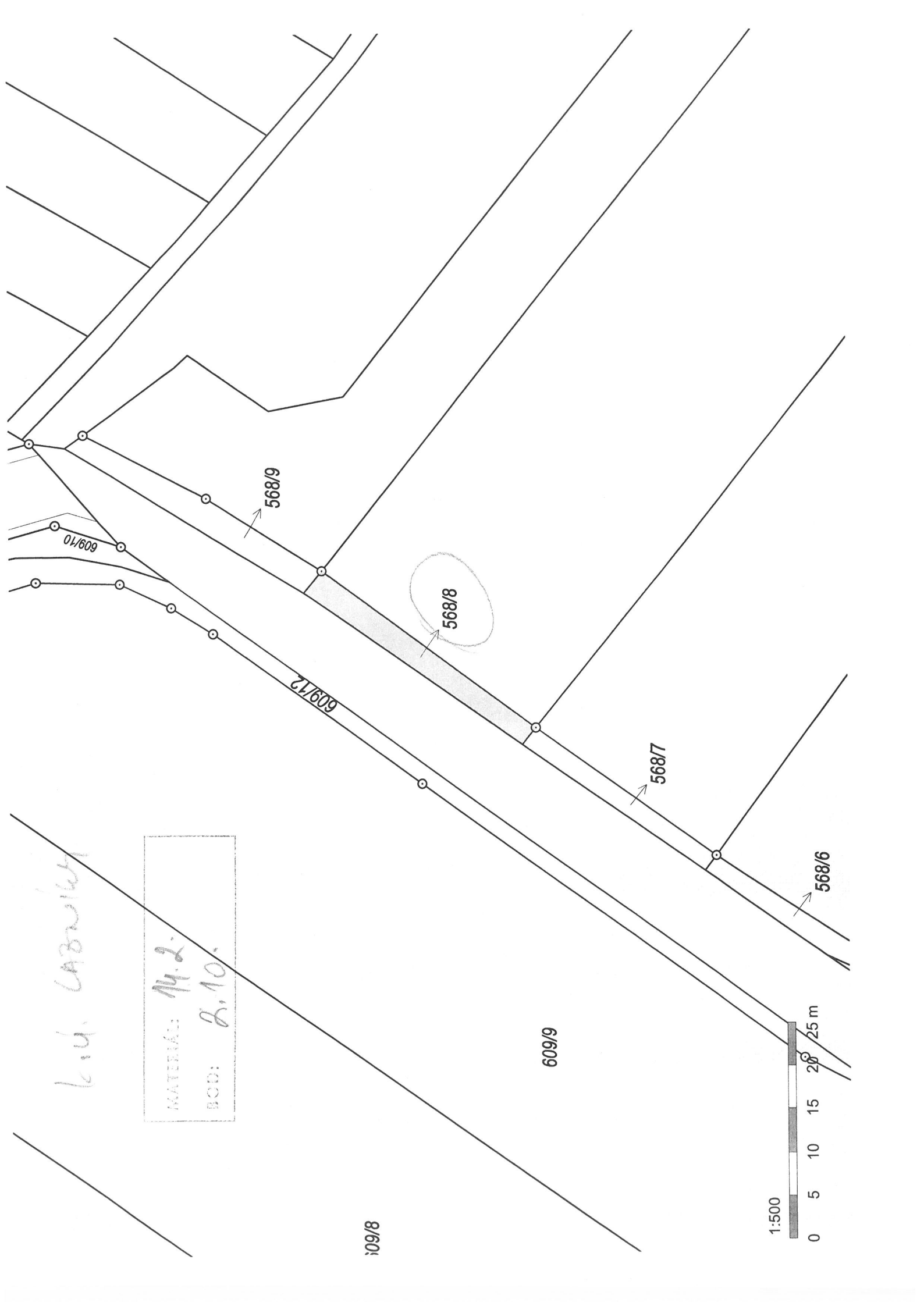

609/8

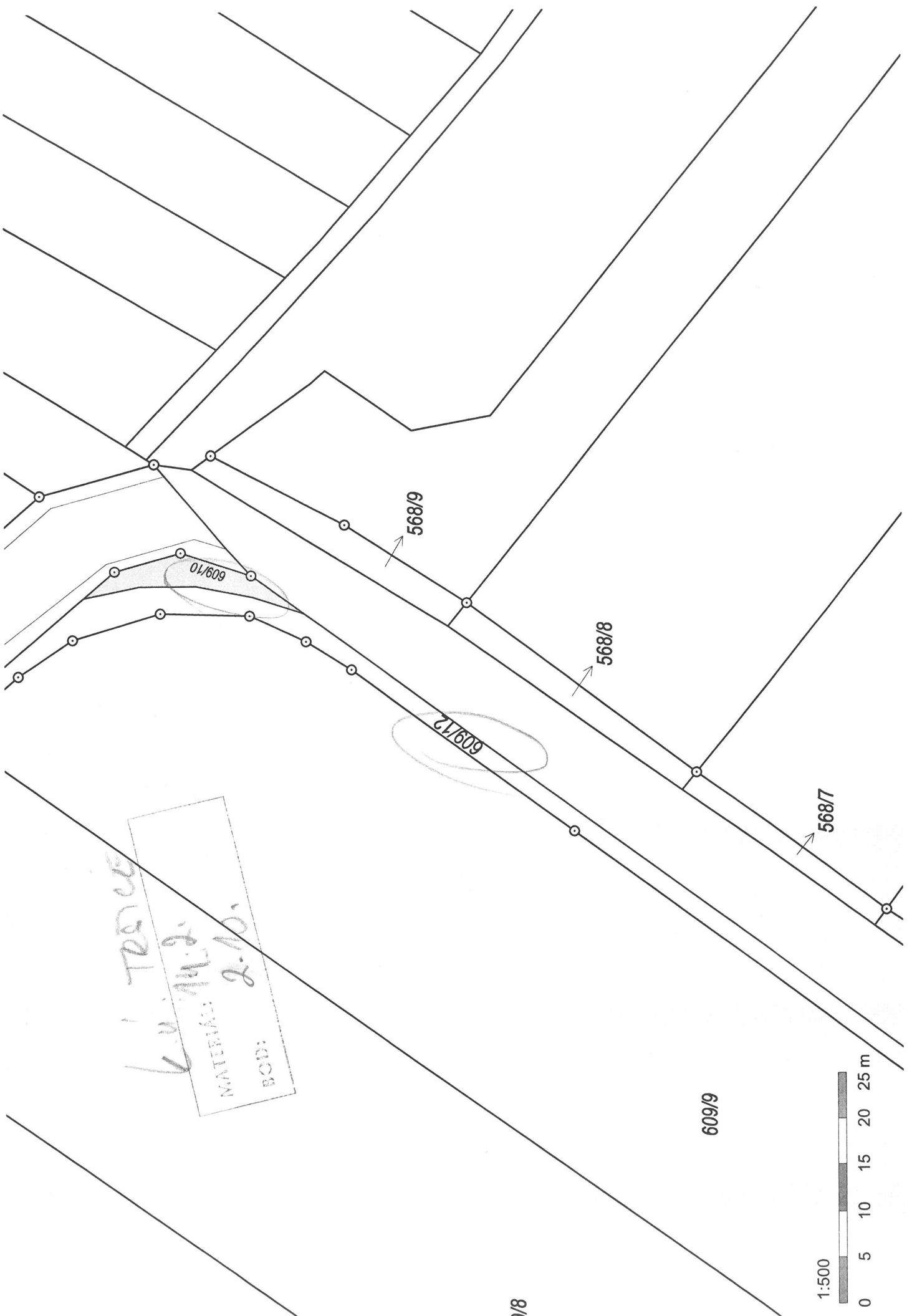

L. V. TESTACE
MATERIA: 2.10.
BOD:

